

Technology Developed in GICE

Software Defined Network Virtualization

from Communication and Signal Processing Group

Abstract

The concepts of Software defined network (SDN) and Network Virtualization [1][2] have drawn much attention these years for their promising architecture of flexible network topology and adaptive service patterns. In this document, SDN will be introduced in the first section, to illustrate its convenience of network management, and the most popular standard of SDN -- OpenFlow will be described in the second section. Network Function Virtualization (NFV)[4], the architecture that uses technologies of virtualization to separate the layered functions of nodes in the Internet into functional blocks, will be introduced in the third section. The forth section will be focused on the combination of SDN, NFV, and OpenFlow, that plots a clear figure of the idea for network virtualization. This document will be concluded by a realistic example that achieves QoS guarantee of data transmission by software defined network virtualization.

Software Defined Network (SDN)

The transmissions of data in the Internet are composed of links of user-to-user and user-to-server and network infrastructure, whereas the transmissions of packets on the links are achieved by routers and switches. These routers and switches are traditionally "closed systems," operated by network managers only through the control interfaces provided by hardware manufacturer. Software-Defined Network separates the control logic from the packet forwarding hardware, making it possible for operating the network by a programmable third-party interface. The applications developed based on the policies of networks instruct the control logic to launch commands to the hardware (infrastructure). The structural layer concept can be illustrated as the Figure 1.

More specifically, SDN architecture contains 5 components [5]: Application, Controller, Datapath, Control-to-Data Plane Interface

(Continued on page 2)

GICE Honors



Prof. Ming-Syan Chen

「The 19th National Professorship of MOE」



Prof. Wanjiun Liao

「The 59th Academic Award of MOE」



Prof. Hung-Yu Wei

「Ta-You Wu Memorial Award of MOST」

In this issue

GICE Honors 1

Message from the Director 2

Technology Developed in GICE
 - Software Defined Network Virtualization 1-5

- A Planar and Subwavelength Open Guided Wave Structure Based on Spoof Surface Plasmons 5-6

Activities
 - Wireless and Optical Communications Conference (WOCC) 2015 7

- The Technology and Application Trends of Vehicular Electronic and Communication Systems 8

Message from the Director



Tzong-Lin Wu

Professor & GICE Director

In this issue, Professor Tsung-Nan Lin published research on "Software Defined Network Virtualization" which provides you with specialized knowledge and skills while Professor Shih-Yuan Chen published research on "A planar and subwavelength Open Guided Wave Structure Based on Spoof Surface Plasmons". Hoping you can substantially gain benefits from these two excellent and abundant research results.

WOCC has become one of the major events for telecommunications professionals both in the world to present new research results, innovative research ideas, and network among telecommunications experts. We highlight this event in this periodical which was successfully held on October 23-24, 2015 in Taipei, Taiwan.

Please enjoy the latest issue and wish everyone have a fruitful year ahead. Happy Chinese new year!

Technology (Continued from page 1)

(CDPI), and Northbound Interface (NBI), as is shown in Figure 2.

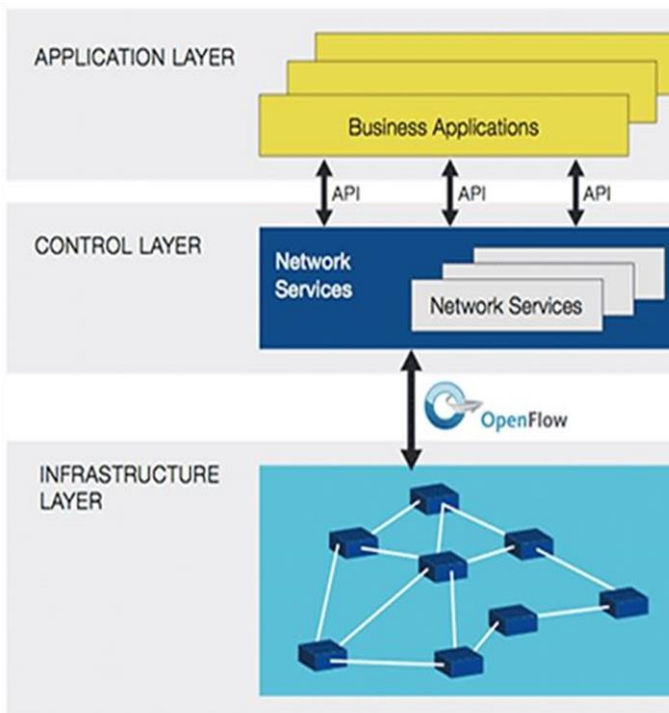
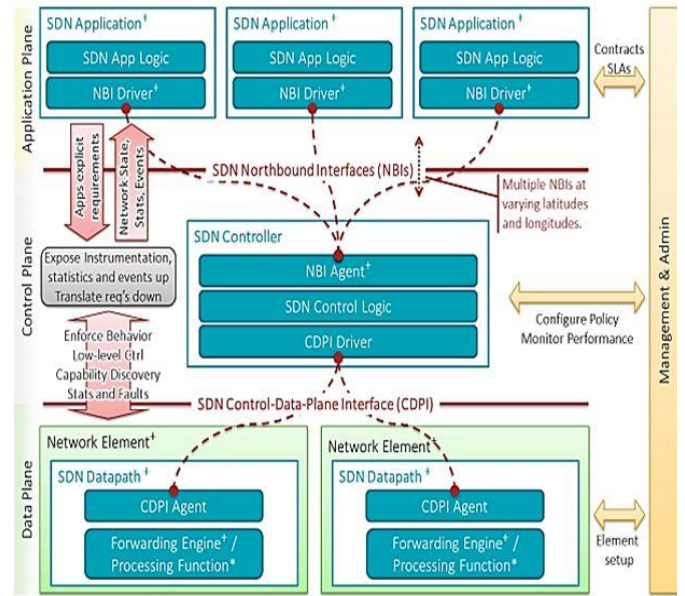

Figure 1. SDN structural layer concept [3]



* indicates one or more instances | * indicates zero or more instances

Figure 2. Components of SDN architecture[5]

1. Application: it is extrinsic, directly programmable, being able to communicate with the controller about the resource requirement or network behaviors through the northbound interface (NBI). Multiple SDN applications can make decisions either dependently or independently, while the priority of independent decisions can be set in the controller.
2. Controller: it is the so-called "control logic," in charge of (1)translating the requirements of network behaviors, network topology, or packet forwarding policies from the applications (2)providing the entire view of the network to the SDN application (including network parameters, statistics, or predefined events).
3. Datapath: it is a logical network device that provides the forwarding of packets and data processing with visibility and uncontended control, and is composed of an SDN Control-to-Data Plane Interface (CDPI) and one or more traffic forwarding engine.
4. CDPI: It is the interface between the controller and datapath, providing (1) programmable controls for all packet forwarding, (2) statistical reports, and (3) notifications of network events.
5. NBI: It is the interface between SDN applications and SDN controller, providing the operation status between them and enabling direct transmitting and receiving of requirements of network resources.

OpenFlow

OpenFlow[3] is currently the most dominating interface of SDN. In the structure of OpenFlow, the forwarding device is called OpenFlow switch.

(Continued on page 3)

Technology *(Continued from page 2)*

OpenFlow switch contains one or more flow tables. Flow tables are composed of flow entries, ruling how the packet, matching the flow entry, is processed or forwarded. A flow entry contains:

- (1) Match Fields: matching the header field of a packet.
- (2) Counters: collecting the packet statistics, such as packet count, packet size, the duration of some flow, etc.
- (3) Actions: to take when a packet matches certain flow entry.

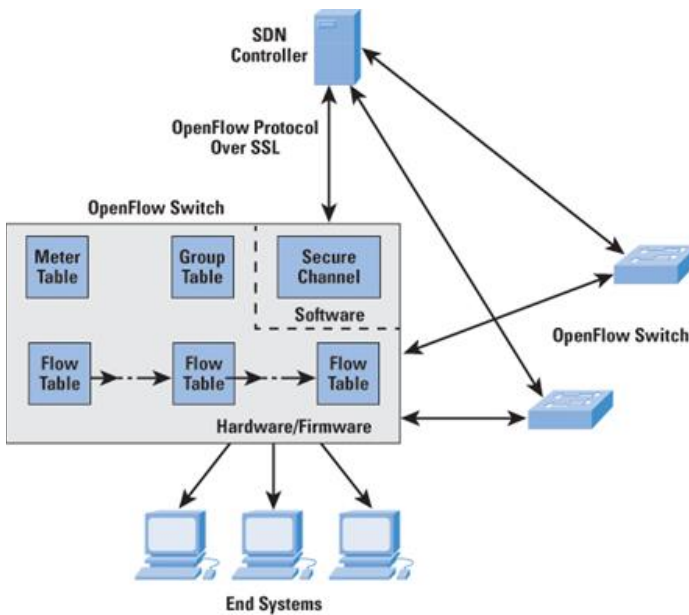

Figure 3. OpenFlow Table Matching [6]

When an OpenFlow switch receives a packet from the Internet, it will parse the information in the header field and try to match it to the flow entries in the default flow table. If the matching does not yield The foundation that aims at improving networking

through SDN and standardizing OpenFlow protocol as well as related technologies is Open Networking Foundation (ONF). It is a nonprofit organization funded by dominant telecommunication companies such as Google, Microsoft, Facebook, Deutsche Telekom, etc.

Network Function Virtualization (NFV)

Network Function Virtualization (NFV) [4][7] is a concept of network architecture, which uses technologies of virtualization to separate the layered functions of nodes in the Internet into functional blocks. Also it leverages software approaches to break the limitations of legacy hardware and eases the deployment of network environments, making it fast and flexible.

The concept of NFV is originated from the fact that hardware performance makes progress quickly in recent years, and many high-level network and information security devices such as routers, firewalls, load balancers, intrusion detection and prevention systems are based on similar specifications of hardware, although the operating systems differ, suggesting that separating the devices from their original specified hardware has the potential to lower maintenance costs and deployment agility.

Currently, the organization in charge of standardizing NFV is a group belonging to European Telecommunications Standards Institute (ETSI). Main members of it are AT&T, BT, CenturyLink, China Mobile, Colt, DT, KDDI, NTT, Orange, Telecom Italia, Telefonica, Telstra, Verizon, etc.

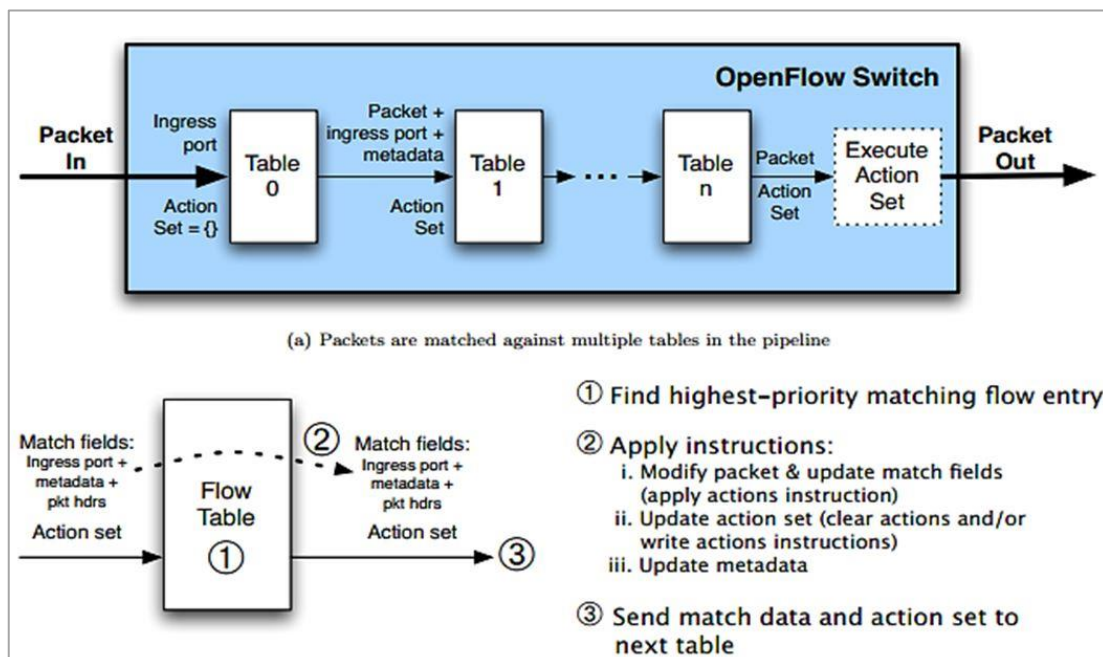

Figure 4. OpenFlow Table Matching [8]

Technology (Continued from page 3)

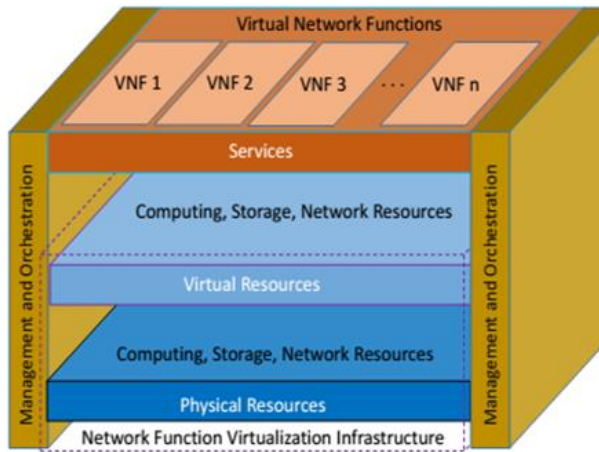

Figure 5. Network Function Virtualization [9]

OpenFlow-based SDN and NFV

NFV and SDN both leverage the benefits of automation and virtualization for achieving higher mobility and flexibility of services. NFV aims at optimizing higher layer network functions (such as firewall, domain name system, load balancer, etc), while SDN focuses on optimizing lower layer network infrastructure.

OpenFlow-based SDN can maximize the utilization of network resources by logically centralized intelligence and network virtualization, and similar results can be accomplished in NFV infrastructure by virtualizing storage and server resources for higher resource utilization suggests lower hardware and operation cost requirement. [10]The deployment of new services of a large scale is often a cumbersome process which takes generally a long period for tests of stability. Taking the advantages of NFV of automatic and flexible management, the service providers will be granted with more time developing new services instead of popularizing one single service. [9]

A Realistic Example - Software Defined Network Virtualization for QoS Guarantee

An OpenFlow meter-based adaptive QoS guaranteed algorithm (OFMAQ) is proposed to show how SDN achieves end-to-end QoS guarantee, which periodically probes the QoS demands, reserving bandwidth adaptively for the high priority flows and isolating priority flows and the rest of lows into different slices. The priority flows could be guaranteed effectively even under the heavy-loaded scenario. In order to reduce the influence on the best-effort traffic due to the reserving bandwidth, an algorithm is proposed to reroute the best-effort traffic statistically to an alternative route, taking the advantage of the concept of group entry in OpenFlow, where different weights in group entry represent different probability of choosing the route.



(a) Original Film



(b) With 100Mbps background best-effort traffic (c) With 100Mbps background best-effort traffic and OFMAQ algorithm

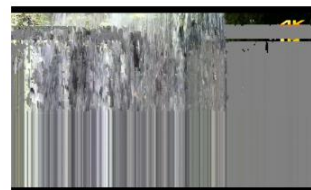

(d) With 90Mbps background best-effort traffic (e) With 80Mbps background best-effort traffic

Conclusion

SDN is an efficient and scalable way to implement network virtualization which has the advantages of flexible management, deployment and innovation of new services.

In this newsletter, we briefly introduce development of SDN, OpenFlow, and Network Function Virtualization. In addition, we propose an SDN based multicast streaming solutions with QoS guarantee.

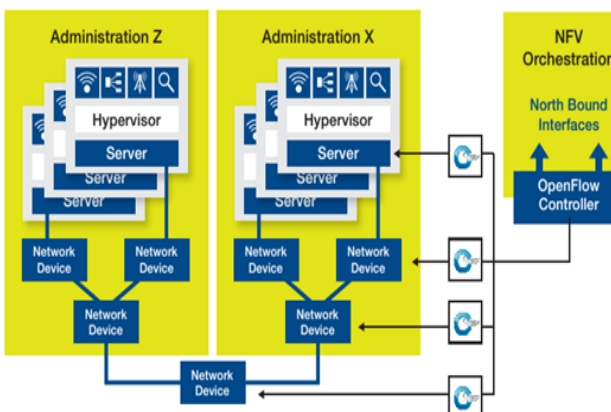

Figure 6. OpenFlow-based SDN facilitates the implementation of NFV[10]

Technology *(Continued from page 4)*

Reference

- [1] Drutskoy, Dmitry, Eric Keller, and Jennifer Rexford. "Scalable network virtualization in software-defined networks." *Internet Computing*, IEEE 17.2 (2013): 20-27.
- [2] Jain, Raj, and Sudipta Paul. "Network virtualization and software defined networking for cloud computing: a survey." *Communications Magazine*, IEEE 51.11 (2013): 24-31.
- [3] <https://www.opennetworking.org/sdn-resources/openflow>
- [4] Wood, Timothy, et al. "Toward a software-based network: integrating software defined networking and network function virtualization." *Network*, IEEE 29.3 (2015): 36-41.
- [5] <https://www.opennetworking.org/images/stories/downloads/sdn-resources/technical-reports/SDN-architecture-overview-1.0.pdf>
- [6] <http://www.cisco.com/web/about/ac123/a>
- [7] c147/archived_issues/ipj_16-1/161_sdn.html
Batalle, Josep, et al. "On the implementation of NFV over an OpenFlow infrastructure: Routing Function Virtualization." *Future Networks and Services (SDN4FNS)*, 2013 IEEE SDN for. IEEE, 2013.
- [8] <https://www.opennetworking.org/images/stories/downloads/sdn-resources/onf-specifications/openflow/openflow-switch-v1.5.1.pdf>
- [9] Mijumbi, Rashid, et al. "Network function virtualization: State-of-the-art and research challenges." (2015).
- [10] <https://www.opennetworking.org/images/stories/downloads/sdn-resources/solution-briefs/sb-sdn-nvf-solution.pdf>

For more information please contact:
 Professor: *Tsung-Nan Lin*
 Email: *Tsungnan@ntu.edu.tw*

A Planar and Subwavelength Open Guided Wave Structure Based on Spoof Surface Plasmons

from Electromagnetics Group

Recently, spoof surface plasmon polaritons (SPPs), also called "plasmonics", have been a hot research area due to its novel electromagnetic properties and application potentials [1]. Spoof SPPs involve the combination of surface plasmons [2] and metamaterials [3]. In our recent work [4], we have proposed a novel compact planar open waveguiding structure based on spoof SPPs. For practicality, instead of the conventional wire medium, the uniaxial strip medium (USM) was proposed and used as effective bulk material with a negative dielectric constant to support the spoof SPP modes. The USM is an artificial nonmagnetic material formed by embedding an array of metallic strips with periods and dimensions considerably smaller than the wavelength into a host medium. Thus, it can readily be implemented by the printed circuit board (PCB) process. The relevant formulations, including the effective dielectric constant of the USM, the modal dispersion relations of the spoof SPP sustained by USM, and the formulation for the waves in a multilayer anisotropic structure, were analytically derived in [4] as well. An experiment was conducted in the anechoic chamber, and an extraction method for obtaining the required reflection spectrum from the measured scattering parameter was also developed. Figs. 1 and 2 show the experimental setup and the calculated, simulated, and measured results, respectively. When the spoof SPP sustained by the USM slab is excited, the energy of the incident wave emitted by the transmitter is coupled with the spoof SPPs.

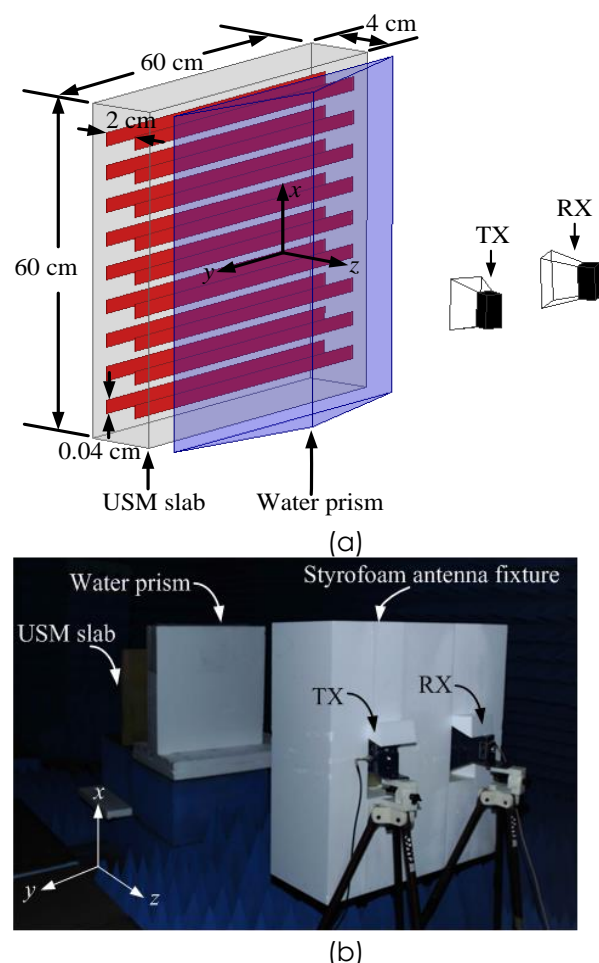

Fig. 1. (a) Schematic and (b) photograph of the experimental setup [4].

(Continued on page 6)

Technology (Continued from page 5)

Hence, a local minimum at the exciting frequency of the spoof SPP can be observed in the reflection spectrum. Interestingly, instead of taming and suppressing the spatial dispersion, which had been done in most past studies [5], [6], spatial dispersion was exploited in our proposed structure to enhance the field confinement of the spoof SPP mode by approximately 41%. In addition to plain USM slabs, a conductor-backed USM (CB-USM) slab was also demonstrated. The thickness of the USM slab could be halved by using conductor backing and without perturbing the odd mode of the spoof SPP. Both the spatial dispersion and conductor-backed structure help avoid electromagnetic interactions among various components within multilayered PCB structure and help miniaturize plasmonic sensors or surface-wave waveguides in the microwave regime. The thickness of the prototype structure was only $0.09\lambda_0$ at 1.34 GHz.

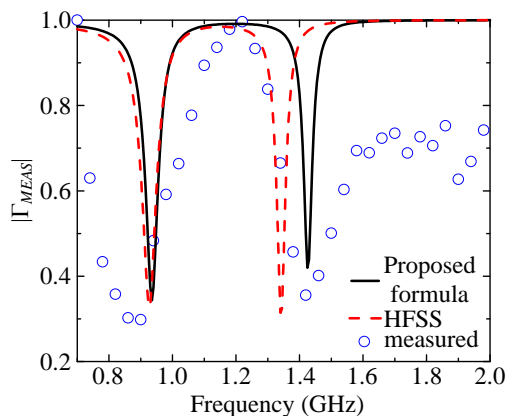

Fig. 2. Reflection spectrums of the prototype USM slab [4].

Additionally, the propagation loss for such slow-wave structures has seldom been discussed analytically and quantitatively. In this study, through calculations and simulations, low attenuation constants in the spoof SPP propagation direction of the proposed structures were investigated.

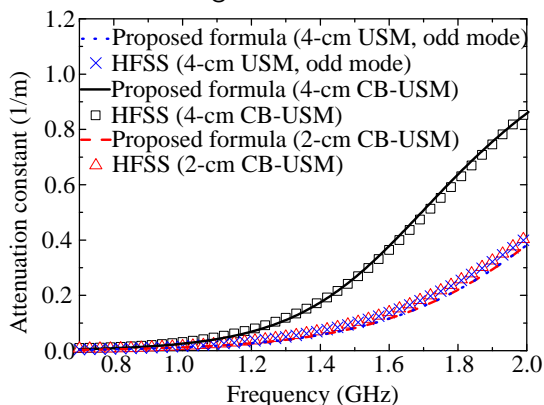

Fig. 3. Attenuation constants of the spoof SPP mode of the prototype CB-USM slab [4].

Fig. 3 shows the attenuation constants of the spoof SPP mode for the prototype CB-USM slab. Clearly, the attenuation constant at 1.34 GHz for our proposed structure is 0.058 m^{-1} . As a comparison, the

attenuation constants of a common $50\text{-}\Omega$ microstrip line fabricated on the same FR4 substrate (1.6 mm thick) is 0.526 m^{-1} at 1.34 GHz, which is about 9 times greater than that of the proposed structure. The reason for the lower propagation loss of our proposed structure is that the modal fields mostly reside in the air region rather than within the CB-USM slab as shown in Fig. 4. The operating frequency of the prototype structures is chosen at lower GHz band merely to facilitate the experimental verification. The proposed structure would work as well at millimeter-wave regime, THz band, or even beyond. We believe that this study presents potentially useful results for plasmonic sensing and waveguiding in both microwave regime and beyond.

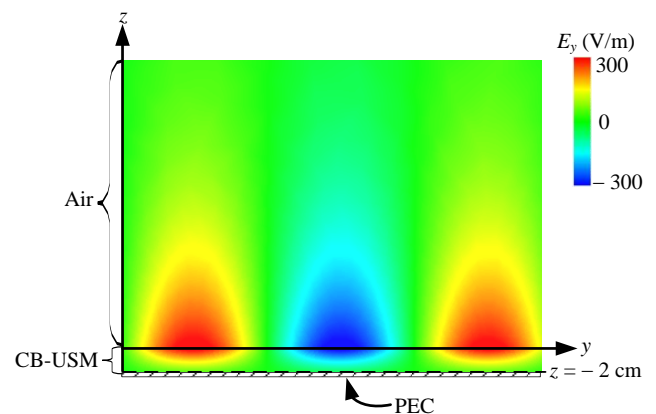

Fig. 4. Simulated modal field distribution of the 2-cm CB-USM slab at 1.34 GHz [4].

References

- [1] S. A. Maier, *Plasmonics: Fundamentals and Applications*, New York: Springer, 2007.
- [2] C. H. Raether, *Surface Plasmons on Smooth and Rough Surfaces and on Gratings*, New York: Springer, 1988.
- [3] L. Solymar and E. Shamonina, *Waves in Metamaterials*, New York: Oxford, 2009.
- [4] L.-Y. Ou Yang, C.-H. Tsai, and S.-Y. Chen, "A planar and subwavelength open guided wave structure based on spoof surface plasmons," *IEEE Photonics Journal*, vol. 6, no. 6, Dec. 2014.
- [5] A. Demetriadou and J. B. Pendry, "Taming spatial dispersion in wire metamaterial," *J. Phys.: Condens. Matter*, vol. 20, no. 29, pp. 295222, Jul. 2008.
- [6] Y. Koshiyama, T. Arima, and T. Uno, "Experimental verification of spoof surface plasmons in wire metamaterials," *Opt. Express*, vol. 20, no. 16, pp. 18238–18247, Jul. 2012.

For more information please contact:
 Professor: Shi-Yuan Chen
 Email: shiyuan@ntu.edu.tw

Activities

Wireless and Optical Communications Conference (WOCC) 2015

The 24th Wireless and Optical Communications Conference (WOCC), organized mainly by NTU professors, was held at the Howard International House, Taipei, on October 23 and 24, 2015. In the past two decades, WOCC has become one of the major events for telecommunications professionals both in the U.S. and the Asia-Pacific region to present new research results, discuss emerging technologies, innovative research ideas, and network among telecommunications experts. The theme of WOCC 2015 is "Connecting the Big Crowd: Communication Network and Big Data in the Era of Internet of Things and 5G", highlighting the convergence and integration of mobile communications, Internet, and big data processing in realizing diverse applications of Internet of Things.

The technical program of WOCC 2015 featured four parallel symposia on: Wireless Communications, Optical Communications, Networking, and Big Data, with five distinguished plenary and keynote presentations delivered by internationally renowned experts, including Prof. Yi-Bing Lin (Deputy Minister, Ministry of Science and Technology, Taiwan), Prof. Zhisheng Niu (Tsinghua University, China), Prof. Gee-Kung Chang (Georgia Institute of Technology, USA), Dr. Edward Chang (President of HTC Healthcare) and Dr. Yucheun Kevin Jou (Senior VP and CTO, MediaTek). It also featured a panel discussion on the convergence of internet of things (IoT) and the fifth generation

(5G) mobile communication networks, with panelists including experts in IoT and 5G such as Dr. I-Kang Fu (MediaTek), Dr. Yi Hsuan (Google), Dr. Howard Huang (Alcatel-Lucent), Dr. Shin-Ming Liu (Intel), Dr. Russell Sun (Alcatel-Lucent), Prof. Hsin-Mu Tsai (NTU), Prof. Hung-Yu Wei (NTU). WOCC 2015 had 49 regular paper presentations and 13 invited talks in its 12 technical sessions, and had attracted over 180 attendees from twelve countries over Asia-Pacific, Europe, and America.



Vice President of NTU, Prof. Liang-Gee Chen (left), who is also the General Chair of WOCC 2015, and Prof. Hsuan-Jung Su (right) of NTU GICE, who is also a TPC Co-chair of WOCC 2015, present a certificate of appreciation to the Plenary Speaker, Prof. Yi-Bing Lin (center), who is the Deputy Minister of the Ministry of Science and Technology (MOST), Taiwan.



The panelists of the panel discussion on the convergence of IoT and 5G. From left to right: Prof. Hung-Yu Wei (NTU), Dr. Yi Hsuan (Google), Dr. I-Kang Fu (MediaTek), Prof. Hsin-Mu Tsai (NTU), Prof. Hsuan-Jung Su (NTU), Dr. Russell Sun (Alcatel-Lucent), Dr. Howard Huang (Alcatel-Lucent), Dr. Shin-Ming Liu (Intel).

Activities

The Technology and Application Trends of Vehicular Electronic and Communication Systems

The second seasonal report of Taiwan Electromagnetic Industry-Academic Consortium in 2015 was held in National Taiwan University on June 4 with a focus on the technology and application trends of vehicular electronics and communications. The aim is to summarize the developing trend from the viewpoints in different aspect to the society. Five topics presented by the experts from the highly recognized organizations in Taiwan have attracted more than 100 attendees from the academic and industrial societies. The presenting organizations include ITRI, NCIST, ARTC, NCTU and FETC, which are the representative organizations from research institutes, academia and industry in Taiwan.



The presentations cover a global scope of vehicular electronic and communication industries. In particular, FETC has demonstrated the success of ETC in Taiwan, and presented their strategies to promote this RFID based technology into the new era of intelligent lives. ARTC has presented the technology development from the regulation and standard point of view, and emphasized the importance of EMC regulation compliance. In the major aspect of technology development, NCIST has dedicated the technology development for decades. The speaker has called the possibility of promotion into civilian applications, which will dramatically enhance the capability of industries and shorten the development time to market. On the other hand, ITRI has been leading in Taiwan in the civilian technologies. They have shown tremendous progresses in the vehicular communication such as the DSRC technologies. In particular, the chief leader Dr. Jiang has demonstrated the technology application examples. Finally Prof. Chung from NCTU showed the progress of vehicle anti-collision radar technology that he has dedicated for more than 10 years. He also showed the importance of anti-collision radar to increase the reaction time for the drivers, which has been shown to reduce the car accidents.



During the report, we have also invited three of our consortium's important members to present their attractions on site with an intension to attract and recruit fresh students-to-graduate. Entertainment activities of lucky draws for prizes have attracted students to participate. Those events and activities in this seasonal report have been very successful to conclude the seasonal activities of TEMIAC.

National Taiwan University Graduate Institute of Communication Engineering

No.1, Sec.4, Roosevelt Road,
Taipei 10617, Taiwan

Phone
+886-2-3366-3075

Fax
+886-2-2368-3824

E-mail
gicenewsletter@ntu.edu.tw

Visit us at:
<http://www.comm.ntu.edu.tw>

Editor in Chief
Prof. Hung-Yu Wei

Editor
Chiao Yun Kang